

TECHNICAL GUIDE

Natural Wood Siding

Selection, Installation & Finishing



Western Wood Products Association



Contents

Grades	2
Pattern Selection	3
Moisture Content	3
Checklist for a Siding Specification	4
Priming and Preenfinishing	4
Installation	5
Pattern & Installation (Nailing) Diagrams	6
Nails & Nailing	8
Finishing	9
Coverage Calculations	10
Checklist for High Performance Siding	11
Additional Information	11
Western Lumber Grade Reference Chart	back cover



Western Wood Products Association
522 SW Fifth Avenue, Suite 500
Portland, OR 97204-2122
503-224-3930 fax: 503-224-3934
e-mail: info@wwpa.org
website: www.wwpa.org

©2007 WWPA

Natural Wood Siding: Selection, Installation & Finishing

Natural Wood Siding

Solid wood has long been used as a siding material. Its natural beauty is timeless and the color and textures available are unmatched by other building products. Such properties make wood siding adaptable to a wide variety of regional preferences, architectural styles and climates.

When correctly installed and maintained, natural wood siding will last for decades and sometimes centuries. It is a prestige product that adds value to a home or commercial building, reflecting both quality materials and professional workmanship.

Grades

Building codes usually consider wood siding a non-structural material and place few restrictions on its use. In addition, model codes do not require that it be grade-stamped.

However, all Western species used for siding are listed under at least one industry-recognized grade rule published by an American Lumber Standard Committee, Inc. accredited rules-writing agency, such as Western Wood Products Association (WWPA).

Western species of the United States include Douglas Fir and Larch, Hemlock and the True Firs, Ponderosa Pine, Lodgepole Pine, Idaho White Pine, Sugar Pine, Engelmann Spruce, Sitka Spruce, White Spruce and the Western Cedars.

Cedar's weather resistance and dimensional stability make it particularly well suited to siding applications, with the added benefit that cedar's heartwood is naturally durable against decay. Clear Heart and Clear VG Heart grading rules include the heart designation. If heartwood is desired in other grades, and sapwood to be limited, then it must be so specified through buyer/seller agreement.

Siding products are generally categorized as either *premium* or *knotty* grades.

Premium grades have fewer characteristics such as knots, pitch streaks and so forth. The highest designations are reserved for clear wood free of characteristics. These grades are generally more expensive and usually sold kiln dried.

While some B&Btr is available, Select grades usually include C and D Select. (Equivalent grade designations in Idaho White Pine are Supreme, Choice and Quality.) Western Red Cedar may be graded as Selects or according to Cedar Rules where comparable grades are Clear Heart, A and B grades. Finish grades include Superior and Prime, and can be used for most Western species but are seldom used for the cedars and pines. Additional grades for bevel patterns are shown in *Table 1*. Specify exact grade desired, by grade rule book and paragraph number.

Knotty grades such as Common, Alternate Board, Select Knotty and Quality Knotty are more abundant as they include material with knots and other characteristics.

Knot size and quality are defined in the grading rules. Sound, tight knots will not adversely affect the performance of the siding. However, encased or unsound knots can become loose and may eventually fall out.

WWPA knotty grades include 1, 2 and 3 Common. (Equivalent grades in Idaho White Pine are Colonial, Sterling and Standard.) These grades are generally referenced as 2&Btr Common and 3&Btr Common for most Western species. (*Refer to notes under Table 1 for additional information.*)

The WCLIB knotty grades for Alternate Boards are Select Merchantable, Construction and Standard. Similar knotty grades for cedar siding are Select Knotty and Quality Knotty.

When selecting knotty siding in any species, specify the exact grade or paragraph number of the grade rule book from an ALSC-

accredited agency. (Paragraph numbers are included in Table 1.)

Some manufacturers market their siding under a variety of names such as STK (select tight knot or sound tight knot) or NPS (no prior selection). These names are helpful but it is important to understand that these are marketing terms and not grade designations from grading agencies.

There are no uniform standards for STK, NPS, etc. Consequently the products so-named may vary in quality from one source to another. STK cedar may be a combination of Select Knotty and Quality Knotty, with a percentage of the order in Quality Knotty.

Pattern Selection

Boards in standard dimensions can be readily used for such siding applications as board-and-batten or board-on-board. However, most siding products are milled or run to a pattern.

Standard patterns are published by the rules-writing agencies to encourage uniformity and to serve as a common reference throughout the industry. The popular patterns are bevel or bungalow, Dolly Varden and channel. (Refer to Figure 3 for profiles of these and other patterns. WWPA's Standard Patterns can be downloaded from www.wwpa.org.)

Patterns not only allow for different effects in design and

appearance but also affect performance. Patterns like tongued-and-grooved, which are primarily paneling patterns, should only be installed in exterior applications where the greatest degree of protection from climatic conditions can be provided. Tongued-and-grooved patterns allow for very little dimensional change as the siding acclimates to the environment, or as a result of seasonal dimensional adjustments. Climate, humidity levels, architectural detailing and exposure to prevailing weather conditions should all be considered when selecting a pattern.

As a rule of thumb, narrow patterns perform best because there is less dimensional change in the siding as the environment changes from wet to dry, or from the freezing conditions of winter to the blistering heat of late summer. Thicker patterns have less tendency to cup or split than do thinner patterns.

Siding surfaces are manufactured smooth, rough, or saw-textured. The type of surface and pattern, in combination with the finishing material, will affect performance. In general, saw-textured surfaces hold finishes longer than smooth surfaces.

Moisture Content

As wood loses or gains moisture, it will shrink or swell until it reaches equilibrium with the level of moisture in the air of its immediate surroundings. Because of its cell structure, wood shrinks primarily in thickness and width and very little in length.

Wood siding is no exception. It will shrink and swell regardless of pattern or material quality. Problems can occur after installation if the siding shrinks or swells unevenly or very rapidly, particularly if it has been improperly nailed and its natural movement has been restricted. However, problems such as twist, cup, warp, splits and checks can be minimized.

To avoid potential problems and to minimize dimensional change after installation, the moisture content of the siding should match the local climate as closely as possible at the time of installation.

Table 1: GRADES

General Categories (Note that there are additional grades for bevel pattern.)		GRADES ⁷			Grade Rule Paragraph Numbers for Reference & Specifying		
		WESTERN SPECIES		CEDAR Western & Canadian	WWPA ²	WCLIB ³	NLGA ⁴
		Selects ¹	Finish				
All Patterns	Premium Grades	C Select⁵	Superior	Clear Heart⁵	20.11	102-b	200a
				A Grade⁵	20.12	102-c	200b
					10.12	–	–
		D Select⁵	Prime		10.51	–	–
					10.13	–	–
				B Grade	10.52	–	–
			20.13	102-d	200c		
Additional Grades for Bevel Patterns	Premium		Superior Bevel	Clear VG Heart⁵	21.11	106-aa	201a
				A Bevel⁵	21.12	106-a	201b
					16.11	–	–
	Knotty		Prime Bevel	B Bevel	21.13	106-b	201c
				Rustic	–	–	201d
				C Bevel	21.14	106-c	201e
All Patterns	Knotty Grades	Commons ¹	Alternate Boards				
		2 Common	Select Merch. Construction	–	30.12	118-a	114a
		3 Common	Standard	Select Knotty⁶	–	111-e	204a
				Quality Knotty⁶	30.13	118-b ⁸	114b ⁸
					–	111-f	204b
					–	118-c ⁹	114c ⁹

¹ Equivalent grades, under the same paragraph numbers in WWPA Rules, are available in Idaho White Pine. Refer to *Western Lumber Grading Rules*.

² Western Wood Products Association's *Western Lumber Grading Rules*.

³ West Coast Lumber Inspection Bureau's *Standard Grading Rules for West Coast Lumber*.

⁴ National Lumber Grades Authority's *Standard Grading Rules for Canadian Lumber*.

⁵ Some clear grades may be specified VG (vertical grain). Common practice is to ship orders as a combination of vertical and flat grain, unless specified otherwise.

⁶ The widely used marketing term, "STK" usually describes a combination of Select Knotty and Quality Knotty, sometimes marketed with approximately 15% of the order in Quality Knotty.

⁷ The grades listed in these three columns are arranged in order of highest to lowest appearance quality; Clear Heart is the highest and Standard and Quality Knotty are the lowest grades in this table.

⁸ Construction grade paragraph reference number.

⁹ Standard grade paragraph reference number.

The grade names in bold face type are the most widely available grades. These are often specified as a grade combination that includes some portion of material in the next higher grade; i.e. C&BTR Select, D&BTR Select, A&BTR Cedar, 2&BTR Common, 3&BTR Common or STAND&BTR (Standard & Better).

For instance, if the climate in a particular region causes wood to maintain 9% to 14% moisture content, then the moisture content of the siding should be within that range when installed.

Siding can be dried at the time of manufacturing to a variety of moisture content levels or it can be shipped from the mill unseasoned or green.

Unseasoned or green wood has a moisture content of more than 19%.

Dry wood will be at a maximum moisture content of 19% or 15%.

Dry siding will take less time to acclimate to the air of its final surroundings (refer to Table 2) and it will have less dimensional change, before and after installation, than unseasoned or green siding.

When ordering siding, specify the required moisture content level, but keep in mind the reality of the marketplace: premium grades of siding are readily available dry; some knotty grades are available dry. Remember too, **dry has a different meaning for the premium grades than it does for the knotty grades.**

Dry for the premium grades means that the siding has been dried to a maximum of 15% moisture content (MC 15). In addition, under WWPA rules, MC 15 means that at least 85% of the pieces in the order will be at a moisture content of 12% or less.

When knotty grades are dried at the mill, the siding is air- or kiln-dried so that it will not exceed 19% moisture content. Thus, **dry knotty siding** will have a moisture content of 19% or less and may be grade-

stamped “S-DRY” or “KD”.

However, knotty grades can be specified MC 15 or KD 15, and are available through a buyer/seller agreement, when a maximum moisture content of 15% is desired.

Method of Drying — Lumber may be air dried or kiln dried. These terms do not necessarily refer to a specific moisture content but refer instead to the method used for drying. **Air dried** lumber has been seasoned by exposure to the atmosphere, without artificial heat.

Kiln dried lumber has been seasoned in a chamber with the use of artificial heat. To assure compliance with a moisture content level, a moisture percentage should always be referenced.

Siding Storage — All siding may pick up or lose moisture in transit or storage so it is important to allow it to acclimate with the surrounding air of its final site prior to installation.

Stack the siding on evenly spaced, vertically aligned stickers (spacers between the layers) in an area where there will be good air flow through the stack. This should be done in an open garage or other area that is protected from the elements.

If stacked over concrete, use 2x4s or 2x6s on edge to elevate the first course of siding at least 3½ inches above the surface of the concrete. If the stack is over wet ground or wet concrete, lay down a vapor barrier so the wood doesn't pick up moisture from beneath the stack.

Allow air to flow through and around the stack for a week to 10 days for *dry* siding, prior to installation. Extend the time period to 30

days or longer, for *unseasoned* siding or if acclimating in exceptionally humid conditions.

Further precautions must be taken if *unseasoned* or *green* materials, with a moisture content of more than 19%, are to be used successfully:

- 1) Allow materials to acclimate, as described, over a longer period—at least 30 days and longer in damp or humid conditions—before installation.
- 2) Use patterns which allow for some shrinkage, such as bevel, channel or board-and-batten. These patterns have a profile that includes a gap that can more easily accommodate dimensional change.
- 3) Use as narrow a width as possible. Dimensional change is proportional; the wider the width, the greater the change.

Priming and Prefinishing

Often, material which has been properly seasoned, stored and handled will pick up moisture after installation but prior to finishing. Later, when the siding loses that moisture, joints may open up.

Research from the U.S. Forest Products Lab indicates that siding exposed to the elements for two

Checklist for a Siding Material Specification

- Select species suited to the project.
- List grade names, paragraph numbers and rules-writing agency. (Refer to Table 1.)
- Specify surface texture for exposed face.
- Specify moisture content suited to the project.
- If gradestamped, specify lumber be stamped on back or ends. (WWPA's **Lumber Specifying** offers additional information.)
- Specify VG (vertical grain) if appropriate and available. (Refer to Table 1, footnote 5.)
- Specify pattern and size. (WWPA's **Standard Patterns** offers additional information.)

Table 2: MOISTURE CONTENT GUIDELINES

Use of Wood in Exterior	Recommended Moisture Content at Time of Installation					
	Most Areas of the U.S.		Dry, Southwestern States		Damp, Warm South-eastern Coastal Areas	
	Average ¹	Individual Pieces	Average ¹	Individual Pieces	Average ¹	Individual Pieces
Siding, Trim and Sheathing	12%	9-14%	9%	7-12%	12%	9-14%

¹To obtain a realistic average, test at least 10% of each item, i.e. 10% of the siding pieces, 10% of the trim pieces and random checks of the sheathing material. It is particularly important to check the sheathing prior to the siding application if it has become wet after installation.

Source: *Wood Handbook*, 1999, from Table 12-2.

Figure A: FURRING STRIPS AND DRAINAGE PLANE

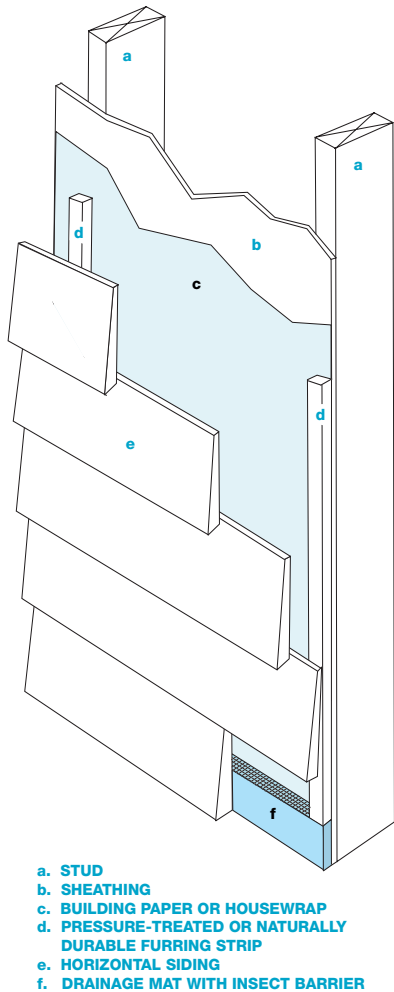

weeks weathers enough to reduce the adhesion of film-forming finishes.

Priming or prefinishing the siding (all sides, edges and cut ends) **after** it has reached climatic balance but **before** it is installed can provide extra protection and often prevent adhesion problems and/or premature finish failure.

Back-priming the siding eliminates the leaching of chemical extractives, which have the potential to degrade sheathing wraps.

Prefinishing is recommended in all circumstances. Prefinishing will minimize objectionable unfinished lines where joints open up due to face-width shrinkage during exceptionally dry summers.

Make certain the prefinish is compatible with the final coat. For example, clear water repellents

should not be used if a bleaching oil is to be the final finish. (Refer to the Finishing section.)

Installation

Natural wood siding should be installed over a weather-resistant barrier regardless of the sheathing material. A weather-resistant barrier is a vapor-permeable sheathing wrap that resists any liquid water that gets behind the siding, and acts as a drainage plane. There are three basic types of sheathing wrap: asphalt felt, Grade D building paper and plastic housewrap. In

order to function as a drainage plane, a sheathing wrap should have an air gap between the wrap and the siding. (An appropriate vapor barrier, on the warm side of the insulation, should be used to reduce moisture movement from inside.) (See Figure A.)

Sometimes referred to as a “rain-screen” wall, the air space behind the exterior siding promotes drainage and ventilation, and allows the drainage plane surface to shed water back to the exterior rather than absorb it. Typically, a 1/8-in. to 1/2-in. air space between the

Figure B: CORNER DETAILS

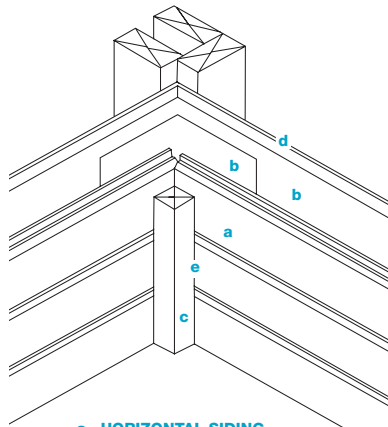

- a. HORIZONTAL SIDING
- b. BUILDING PAPER
- c. TRIM
- d. SHEATHING
- e. CAULK

Inside Corner Detail-a

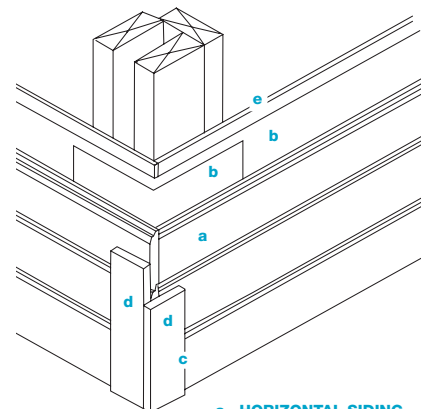

- a. HORIZONTAL SIDING
- b. BUILDING PAPER
- c. CAULK
- d. CORNER BOARDS
- e. SHEATHING

Outside Corner Detail-a

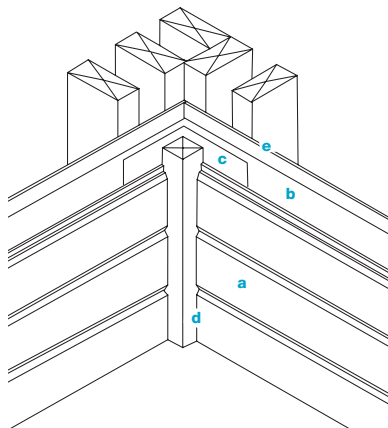

- a. HORIZONTAL SIDING
- b. BUILDING PAPER
- c. METAL FLASHING OR BUILDING PAPER
- d. USE CAULK AT INSIDE CORNER OR OPEN JOINT. PROVIDE METAL FLASHING BEHIND JOINT IF CAULK IS NOT USED.
- e. SHEATHING



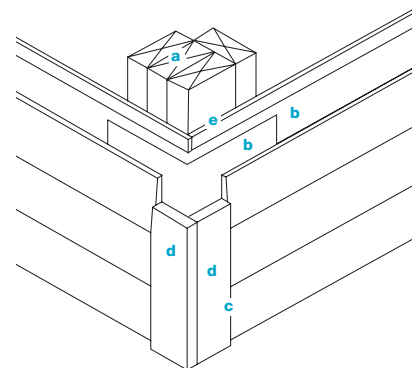





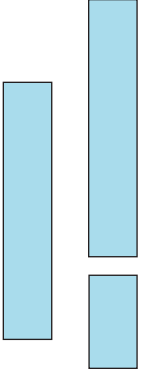
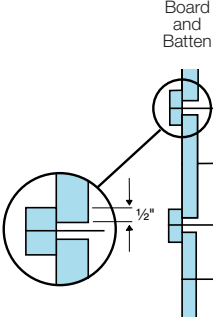
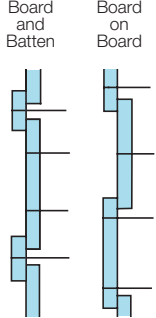

Inside Corner Detail-b

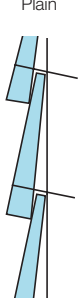
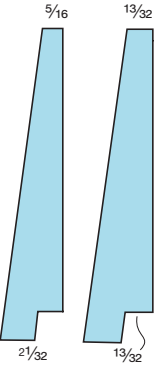

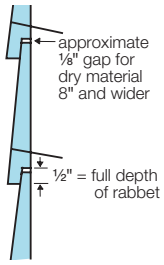
- a. PROVIDE ADDITIONAL STUD TO ALLOW FOR NAILING AT ENDS OF SIDING
- b. BUILDING PAPER
- c. CAULK
- d. CORNER BOARDS
- e. SHEATHING

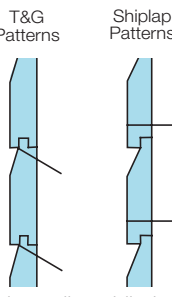

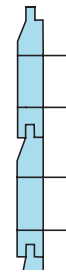

Outside Corner Detail-b

Figure C: SIDING PATTERNS, NOMINAL SIZES & RECOMMENDED NAILING

Siding Patterns	Nominal Sizes* Thickness & Width	Nailing 6" and Narrower	8" and Wider
 <p>TRIM BOARD-ON-BOARD BOARD-AND-BATTEN Boards are surfaced smooth, rough or saw-textured. Rustic ranch-style appearance. Provide horizontal nailing members. Do not nail through overlapping pieces. Vertical applications only.</p>	<p>1 x 2 1 x 4 1 x 6 1 x 8 1 x 10 1 x 12</p> <p>1 1/4 x 6 1 1/4 x 8 1 1/4 x 10 1 1/4 x 12</p>	 <p>Board and Batten</p>	 <p>Board on Board</p>
 <p>3/16 3/16 19/32 3/4</p> <p>BEVEL or BUNGALOW Bungalow ("Colonial") is slightly thicker than Bevel. Either can be used with the smooth or saw-faced surface exposed. Patterns provide a traditional-style appearance. Recommend a 1" overlap. Do not nail through overlapping pieces. Horizontal applications only. Cedar Bevel is also available in 7/8 x 10, 12.</p>	<p>1/2 x 2 1/2 x 4 1/2 x 5 1/2 x 6</p> <p>5/8 x 8 5/8 x 10</p> <p>3/4 x 6 3/4 x 8 3/4 x 10</p>	<p>Plain</p> 	<p>Plain</p> 
 <p>5/16 13/32 21/32 13/32</p> <p>DOLLY VARDEN Dolly Varden is thicker than Bevel and has a rabbeted edge. Surfaced smooth or saw-textured. Provides a traditional-style appearance. Allows for a 1/2" overlap, including an approximate 1/8" gap. Do not nail through overlapping pieces. Horizontal applications only. Cedar Dolly Varden is also available in 7/8 x 10, 12.</p>	<p>Standard Dolly Varden 3/4 x 6 3/4 x 8 3/4 x 10</p> <p>Thick Dolly Varden 1 x 6 1 x 8 1 x 10 1 x 12</p>	<p>Rabbeted Edge</p> 	<p>Rabbeted Edge</p>  <p>← approximate 1/8" gap for dry material 8" and wider</p> <p>1/2" = full depth of rabbet</p>
 <p>DROP Drop siding is available in 13 patterns, in smooth, rough or saw-textured surfaces. Some are T&G, others shiplapped. Refer to <i>Standard Patterns</i> (G-16) for dimensional pattern profiles. A variety of looks can be achieved with the different patterns. Do not nail through overlapping pieces. Horizontal or vertical applications. Tongued edge up in horizontal applications</p>	<p>3/4 x 6 3/4 x 8 3/4 x 10</p>	<p>T&G Patterns</p> 	<p>Shiplap Patterns</p> 
		<p>T&G Patterns</p> 	<p>Shiplap Patterns</p>  <p>← approximate 1/8" gap for dry material 8" and wider</p> <p>1/2" = full depth of rabbet</p>
		<p>Use casing nails to blind nail T&G patterns, one nail per bearing. Use siding or box nails to face nail shiplap patterns, 1" up from bottom edge.</p>	<p>Use two siding or box nails, 3-4" apart to face nail, 1" up from bottom edge.</p>

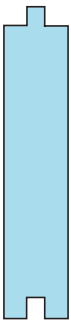
*Note: Refer to WWPA's Standard Patterns (G-16) for scale profiles and actual dimensions of run-to-pattern products.

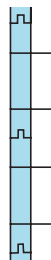
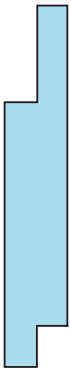
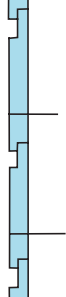
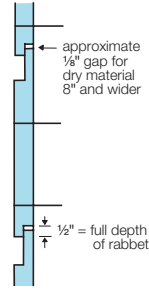
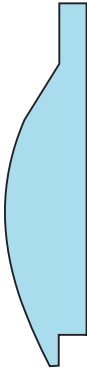
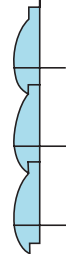
Figure C: SIDING PATTERNS, NOMINAL SIZES & RECOMMENDED NAILING

Siding Patterns	Nominal Sizes* Thickness & Width	Nailing	
		6" and Narrower	8" and Wider
 <p>TONGUED & GROOVED Tongued & Grooved siding is available in a variety of patterns. T&G lends itself to different effects aesthetically. Refer to <i>Standard Patterns</i> (G-16) for pattern profiles. Sizes given here are for Plain Tongued & Grooved. Do not nail through overlapping pieces. Horizontal or vertical applications. Tongued edge up in horizontal applications.</p>	<p>1 x 4 1 x 6 1 x 8 1 x 10 1 x 12</p> <p>Note: T&G patterns may be ordered with 1/4, 3/8, or 7/16" tongues. For wider widths, specify the longer tongue and pattern.</p>	<p>Plain</p>  <p>Use one casing nail per bearing to blind nail.</p>	<p>Plain</p>  <p>Use two siding or box nails 3-4" apart to face nail.</p>
 <p>CHANNEL RUSTIC Channel Rustic has a 1/2" overlap, including an approximate 1/8" gap, and a 1" to 1 1/4" channel when installed. The profile allows for maximum dimensional change without adversely affecting appearance in climates of highly variable moisture levels between seasons. Available smooth, rough or saw-textured. Do not nail through overlapping pieces. Horizontal or vertical applications.</p>	<p>3/4 x 6 3/4 x 8 3/4 x 10</p>	 <p>Use one siding or box nail to face nail once per bearing, 1" up from bottom edge.</p>	 <p>Use two siding or box nails 3-4" apart per bearing.</p> <p>approximate 1/8" gap for dry material 8" and wider</p> <p>1/2" = full depth of rabbet</p>
 <p>LOG CABIN Log Cabin siding is 1 1/2" thick at the thickest point. Ideally suited to informal buildings in rustic settings. The pattern may be milled from appearance grades (Commons) or dimension grades (2x material). Allows for 1/2" overlap, including an approximate 1/8" gap. Do not nail through overlapping pieces. Horizontal or vertical applications.</p>	<p>1 1/2 x 6 1 1/2 x 8 1 1/2 x 10 1 1/2 x 12</p>	 <p>Use one siding or box nail to face nail once per bearing, 1 1/2" up from bottom edge.</p>	 <p>Use two siding or box nails, 3-4" apart, per bearing to face nail.</p> <p>approximate 1/8" gap for dry material 8" and wider</p> <p>1/2" = full depth of rabbet</p>

*Note: Refer to WWPA's *Standard Patterns* (G-16) for scale profiles and actual dimensions of run-to-pattern products.

Siding Installation Tips

- Do not nail through overlapping pieces. Use stainless steel, high tensile strength aluminum, or hot-dipped galvanized nails with ring or spiral-threaded shanks. Use casing nails to blind nail; siding or box nails to face nail.
- Horizontal applications only for Bevel, Bungalow and Dolly Varden.
- Vertical applications only for Board-on-Board or Board-and-Batten; bevel cut ends of pieces and install so water is directed to outside.
- Horizontal or vertical applications for Tongued & Grooved, Channel Rustic, Log Cabin or Drop patterns. Tongued edge up in horizontal applications of Drop and T&G patterns.
- Read the section on *Nail Penetration and Spacing* to determine nail size.
- Read the sections on *Moisture Content* and *Priming and Prefinishing* before installing siding.

sheathing wrap and siding is achieved by applying vertical furring strips over the wrap.

Should water find a way behind the siding, the vented space allows moisture to dissipate naturally, reducing premature finish failures and directing water downward and outward, away from moisture sensitive materials. Corrugated sheathing wraps and three-dimensional drainage fabrics also have been developed to provide drainage, even when siding is installed directly against the material.

When sheathing material or sheathing wrap surfaces become wet, allow surfaces to dry before the wood siding is nailed into position.

Many patterns may be installed horizontally or vertically. Pattern orientation should restrict the entrance of moisture and weather. Some patterns, such as board-and-batten, may be installed only in a vertical fashion. Others, such as bungalow, bevel and drop, may be installed only horizontally.

Where two pieces of siding meet—particularly in vertical applications—miter cut the ends at 45 degree angles to create an overlapping joint. Make sure the joints meet on studs, blocking or furring strips for secure nailing.

Use caulk where siding abuts openings or trim. Latex-silicone blends, polyurethane and polysulfide caulks should give satisfactory performance. Caulks made of 100% silicone are not recommended.

Theoretically, any pattern which can be installed in either direction, such as channel or tongued-and-grooved, can also be installed diagonally. However, diagonal installation tends to channel water directly into door jambs, window casings or other joinery details on a structure.

If siding is to be installed diagonally, the project must be designed from the outset to accommodate the direction of run-off.

When wood siding is installed over metal studs, concrete or masonry, provide 2x nailers of sufficient spacing and size to meet the nailing requirements. This procedure is sometimes used when wood siding is installed over foam sheathing. (Refer to *Nail Penetration and Spacing*.)

Nails and Nailing

Correct nails and nailing practices are essential in the proper application of wood siding. In general, siding and box nails are used for face nailing and casing nails are used for blind nailing. Nail locations are included with the individual patterns in *Figure C*.

Recommended Nails

Nails must be corrosion-resistant and preferably rust proof. Avoid using staples.

1. **Stainless steel.** The best choice.
2. **High tensile strength aluminum.** An economical choice. This nail is corrosion resistant and will not discolor or cause deterioration of the wood siding. However, aluminum nails will react with galvanized metal causing corrosion. Do not use aluminum nails on galvanized flashing (nor galvanized nails on aluminum flashing).
3. **Hot-dipped galvanized.** This nail is the least expensive, but may result in discoloration if precautions are not taken.

(a) Make certain the nails are of top quality, as the degree of protective coating varies with the hot-dip galvanization process.

(b) In some instances, the use of hot-dipped galvanized nails along with clear finishes on Western Red Cedar has resulted in stains around the nails. While this occurrence seems to be limited to the northeastern and north central regions of the country, **the combination of hot-dipped galvanized nails with clear finishes on Western Red Cedar is not recommended.**

(c) Plastic hammer-head covers can be used when driving hot-dipped galvanized nails. This will reduce the potential for chipping and the subsequent potential for corrosion.

4. **Other fasteners.** Other types of corrosion-resistant fasteners may perform satisfactorily. Before selecting an alternative fastener, check with the fastener manufacturer to determine whether or not it is suitable with the species

of wood used for the siding.

Avoid fasteners that may result in stains. **Do not use staples or electro-plated nails. These fasteners often result in black iron stains which can be permanent.**

Copper nails are not suitable for Western Red Cedar as cedar's natural extractives will react with the copper, causing the nails to corrode and resulting in stains on the siding.

While budgets are always a consideration, high-quality nails for solid wood siding are a wise investment. The discoloration, streaking or staining that can occur with inappropriate nails ruins the appearance of the project and can be very difficult to remove.

Nail Shanks

Many nails have smooth shanks and will loosen as the siding expands and contracts under the extremes of seasonal changes in temperature and humidity. Ring or spiral-threaded nail shanks will increase the holding power. Both types of shanks are readily available.

Nail Points

The most commonly used nail points include:

Blunt — reduces splitting.

Diamond — most commonly used.

Needle — should be avoided as needle points tend to cause splitting.

Figure D: NAIL TYPES

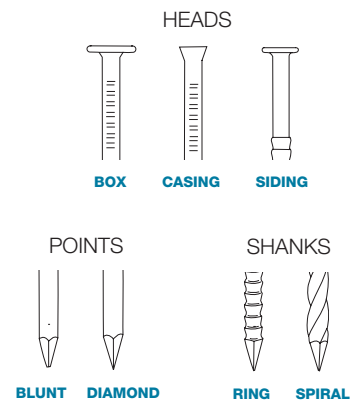

Table 3: NAIL LENGTHS

12d	3 1/4"
10d	3"
9d	2 3/4"
8d	2 1/2"
7d	2 1/4"
6d	2"
5d	1 3/4"
4d	1 1/2"
3d	1 1/4"
2d	1"

Nail Penetration and Spacing

Recommended penetration into studs or blocking, or into a combination of wood sheathing and these members, is 1 1/2". Penetration is 1 1/4" with ring shank nails.

Vertical siding, when applied over wood-based sheathing, should be nailed to horizontal blocking or other wood framing members not exceeding 36" on center when face-nailed, or 32" on center when blind-nailed.

Vertical siding, when installed without sheathing, should be nailed to wood framing or blocking members at 24" on center. Some building codes require 24" on center with or without sheathing; check your local code to verify requirements. Cut bevel (scarf) joints for vertical installations.

Horizontal and diagonal siding should be nailed to studs at 24" on center maximum when applied over wood-based, solid sheathing and 16" on center maximum when applied without sheathing.

The siding pattern will determine the exact nail size, placement and number of nails required. (*Refer to Figure C.*) Nails are placed to allow the wood to move, that is to shrink and swell, as well as to adequately hold the siding in place.

As a general rule, each piece of siding is nailed independently of its neighboring pieces. Do not nail through two overlapping pieces of siding with the same nail as this practice will restrict the natural movement of the siding and may cause unnecessary problems. Nail joints into the studs or blocking members.

Drive nails carefully. Hand nailing is preferred over pneumatic nailing because there is less control of placement and driving force with pneumatic nailers. Nails should be snug, but not overdriven. Nails that are overdriven can distort the wood and may cause excessive splitting. Overdriven nails also provide an avenue for moisture to collect and move through the piece. Predrilling near the ends will help reduce any splitting that can occur with thinner patterns.

For additional information regarding pneumatic nailing, contact the International Staple, Nail and Tool Association at www.isanta.org

Finishing

Natural wood siding can be finished with a variety of products to achieve just about any look desired. Finishes not only enhance the appearance of the wood, but also protect the siding against the detrimental effects of water, mildew and ultraviolet light.

Among the wide range of exterior finishing products available, most finishes fall into four general categories: clear water repellents, bleaching oils, stains and paints.

When choosing a particular finish, consider the desired appearance, preparation and maintenance requirements of the finish, location of the structure and current condition of the siding.

Some people prefer to leave natural wood siding unfinished, in hopes for a weathered appearance. This is not recommended. Siding without a finish can weather unevenly and is prone to surface mold, ultraviolet degradation and moisture-related problems such as cupping and splitting. With the correct type of finish, a natural weathered look can be achieved while providing protection for the siding to promote optimum performance over the years.

Clear Water Repellents

Clear water repellents are one way to achieve a natural look. These products do not add color to the siding and the natural colors and grain patterns can be seen

through the finish. These repellents are often used on cedar siding when a weathered, silvery-grey color is desired.

Clear water repellents will not maintain the brand new look of siding because they do not prevent the sun's ultraviolet rays from fading the wood. Instead, water repellents allow the wood to fade naturally according to the amount of exposure the wood receives. However, some water repellents do contain ultraviolet inhibitors or UV blockers that help minimize the effects of the sun.

Always choose a water repellent that is formulated for wood and contains a mildewcide to help prevent discoloration caused by mildew.

Water repellents are sometimes formulated with a preservative, such as zinc naphthanate, that offers additional protection against decay. These are particularly useful in areas where the siding is constantly subjected to high moisture.

Some copper-based preservatives, such as copper naphthanate, may not be desirable because they have a green tint.

When paint is to be the final finish, paintable clear water-repellent preservatives can also be applied prior to the prime coat to increase the service life of the top coats. Clear water repellents should not be used under a bleaching oil finish.

Clear water repellents can be expected to last from six months to two years, depending on the surface texture of the siding and the location and exposure of the structure.

Bleaching Oils and Bleaching Stains

Bleaching oils and bleaching stains, sometimes called *weathering stains*, are another way to achieve a grey weathered look, but the effect happens faster and the protection offered is longer-lived than with a clear water repellent.

Bleaching products are similar to semi-transparent stains but contain an added ingredient which causes the wood to bleach to a silver color within approximately six to 12

months. They are typically used on cedar siding.

Because of the pigmentation included in the formulation, bleaching oils and stains will color the wood grey upon application. Then, as the siding is exposed to sun and water, the bleaching oils begin to bleach the wood itself, resulting in a more uniform weathered look than can be achieved naturally.

Bleaching oils bring about a silvery-grey appearance that can last for many years. However, the protection offered by the oils may only last two or three years. Consequently, it is a good idea to periodically apply a clear water repellent to the siding, over the bleaching oil, to protect it but not alter the color. If siding color becomes uneven over time, simply reapply another coat of bleaching oil.

Stains

Stains are pigmented finishes that provide color and protection against ultraviolet rays. Many are also water repellents and may include mildewcides and preservatives as well.

When selecting a stain, make sure it is a water-repellent stain that contains at least a mildewcide. Stains are recommended for use on rough or saw-textured siding.

Stains are classified as semitransparent and opaque.

Semitransparent stains have a moderate amount of pigment, provide a fairly uniform color without hiding the wood grain. Oil-based, semi-transparent stains are recommended as they penetrate the wood surface more than water-based products.

As semitransparent stains do not form a film, they are not subject to peeling or blistering but do wear off gradually.

Semitransparent stains can be expected to last from two to five years, depending on the surface texture of the wood, the exposure conditions and the number of previous applications. For first-time applications on saw-textured siding, semitransparent stains may last two years. Subsequent applications

may last up to five years.

Semitransparent stains do not last as long on smooth sidings.

Opaque (solid or heavy-body) stains, have more pigment than semitransparent stains. Think of them as thin paints. Wood grain and color are not visible through opaque stains, but surface texture (roughness) is.

Opaque stains are available in oil- or water-based formulations; however, oil-based formulations are recommended for cedar siding.

Opaque stains may form a thin film on the wood surface and some can be subject to flaking. Opaque stains are not recommended over smooth siding unless a compatible primer is used prior to staining.

Service life is typically three to seven years, depending on the surface texture, exposure of the building and number of previous applications.

Primers and Paint

A paint system, properly applied, will provide more protection and last longer than other finishes. Paints are film-forming finishes that resist moisture absorption and block ultraviolet rays. The variety of colors makes paint a popular finish; lighter colors are recommended over darker colors.

If good performance is to be expected, primers must be used. Primers are generally oil or water-based. Acrylic latex (water-based) primers are recommended for most wood species.

However, for woods naturally high in extractive content, such as Western Red Cedar, *stain-blocking (oil-based or latex) primers must be used* to help minimize discolorations that can occur when water interacts with the natural extractives, causing them to bleed through the surface of the primer. The primer must prevent the natural extractives in the wood from interacting with the water in subsequent finish coats.

Paints are formulated using either an oil (or alkyd) base or water base.

Oil-based paints are generally more effective at blocking moisture than are acrylic latex paints. However, oil-based paints tend to form

a more rigid film that can crack or blister if the wood moves excessively as a result of changes in humidity.

Acrylic latex paints are more flexible and will consequently shrink and expand with the wood, making them less prone to cracking.

The recommended application for most species is one brush coat of acrylic latex primer followed by two coats of 100% acrylic latex paint.

For species high in extractives such as Cedar, use an oil-based primer or stain-blocking latex primer, then two coats of acrylic latex paint.

To enhance the performance of a paint finish, prefinish the siding with one coat (or dip) of a paint-compatible water-repellent preservative prior to priming and painting. This can increase the life of the finish by up to 10 years.

Finishes to Avoid

Do not use varnishes, lacquers or other clear, film-forming finishes on exposed wood. These finishes become brittle, allow UV degradation, can crack and peel, and are difficult to remove. Also avoid pure linseed oil or linseed oil/turpentine mixtures. Such finishes attract dirt and are prone to mildew.

Application Methods

The best method for applying most finishes is with a brush (water repellents may be dipped). Brushing usually puts more finish on the wood surface, extending its service life. On rough-sawn siding, a brush serves to work the finish around the rough wood fibers.

All siding surfaces (face, edges, ends and back side) should have a coat of protection before installation.

When all surfaces are coated, moisture movement in and out of the siding is equalized and the potential for cupping and splitting is minimized.

Prefinishing also minimizes unfinished lines that can occur at joints and laps if the siding shrinks during exceptionally dry summers.

Coverage Calculations

Siding is usually sold either by the lineal (*running*) foot or by the board foot.

To simplify cost and coverage estimations, select the appropriate factor from *Table 4* according to how the siding is priced. The factors provided in *Table 4* can be used to calculate the amount of siding required either in lineal feet or in board feet.

In either case, the square footage of the area to be covered is calculated first, then multiplied by the appropriate factor.

Procedure:

- A) Calculate the square footage in walls:
length x width = sq. ft.
- B) Calculate and then subtract the square footage of openings. Now add 10% for trim and waste.
- C) Multiply the result by either the factor for lineal feet or the factor for board feet.
- D) Multiply the total footage required by price.

Additional Information

Technical information on Western lumber products manufactured by WWPA mills is available through the Association's Online Technical Guide at www.wwpa.org. Free registration is required. The Online Guide features sections on lumber grades, design values, specifications and properties of Western lumber.

For a full description of technical publications available for purchase or download, go to the Online Literature Store on the WWPA web site.

Table 4: COVERAGE ESTIMATOR

Pattern	Nominal Width	Width		Factor for Lineal Feet ¹	Factor for Board Feet ²
		Dressed	Exposed Face		
Bevel & Bungalow	4	3½	2½	4.8	1.60
	6	5½	4½	2.67	1.33
	8	7¼	6¼	1.92	1.28
	10	9¼	8¼	1.45	1.21
Dolly Varden	4	3½	3	4.0	1.33
	6	5½	5	2.4	1.2
	8	7¼	6¾	1.78	1.19
	10	9¼	8¾	1.37	1.14
Drop, T&G and Channel Rustic	12	11¼	10¾	1.12	1.12
	4	3⅝	3⅝	3.84	1.28
	6	5⅝	5⅝	2.34	1.17
	8	7⅝	6⅝	1.75	1.16
Log Cabin	10	9⅝	8⅝	1.35	1.13
	6	5⅞	4⅞	2.43	2.43
	8	7⅞	6⅞	1.81	2.42
	10	9⅞	8⅞	1.39	2.32
Boards	2	1½	The exposed face width will vary depending on size selected and on how the boards-and-battens or boards-on-boards are applied. Minimum overlap is ½". Determine the exposed face, then refer to footnotes to calculate factor.		
	4	3½			
	6	5½			
	8	7¼			
	10	9¼			

¹ Lineal Foot Factor is derived by dividing 12" by the exposed face width.

² Board Foot Factor is derived by dividing the nominal width by the exposed face width and is based on nominal 1" stock, except log cabin. Log cabin is based on 2" thickness. For nominal 1½" log cabin, multiply by .75.

Note: Factors do not include any allowance for trim or waste and do not apply to diagonal installations. A 10% allowance for trim and waste (25-30% for diagonal installations) should be added to the square footage required before the factors are used. Refer to *Procedure* at left.

Checklist for High Performance, Long-Lasting, Beautiful Natural Wood Siding

- Select climate- and design-appropriate patterns with surface textures appropriate for the desired finish.
- Specify species and grade compatible with budget.
- Allow siding to acclimate at job site.
- Prefinish all surfaces (sides, edges, ends) with:
 - water repellent that contains a mildewcide (and is compatible with the final finish), and/or*
 - stain or bleaching oil, if one of these is to be the final finish, or
 - primer, if paint is to be the final finish.
- Use an appropriate sheathing wrap. Make certain it is dry before applying siding.
- Allow for drainage between the sheathing wrap and the siding.
- Apply siding, using the right nails, in accordance with correct nailing procedures. Incorporate appropriate construction practices at corners.
- Provide additional coats of protective finish as required.

*While water repellents are not recommended for use under most stains, they can be used to coat the backside of siding when stain or bleaching oil will be applied to face, edges and ends.

Western Lumber Grades for Siding Products

General Categories <i>(Note that there are additional grades for bevel pattern.)</i>		GRADES ⁷			Grade Rule Paragraph Numbers for Reference & Specifying		
		WESTERN SPECIES		CEDAR Western & Canadian	WWPA ²	WCLIB ³	NLGA ⁴
		Selects ¹	Finish				
All Patterns	Premium Grades	C Select ⁵	Superior	Clear Heart ⁵ A Grade ⁵	20.11	102-b	200a
					20.12	102-c	200b
					10.12	–	–
		D Select ⁵	Prime	B Grade	10.51	–	–
					10.13	–	–
					10.52	–	–
				20.13	102-d	200c	
Additional Grades for Bevel Patterns	Premium		Superior Bevel	Clear VG Heart ⁵ A Bevel ⁵	21.11	106-aa	201a
					21.12	106-a	201b
					16.11	–	–
	Knotty		Prime Bevel	Select Knotty ⁶ Quality Knotty ⁶	21.13	106-b	201c
					–	–	201d
					21.14	106-c	201e
All Patterns	Knotty Grades	Commons ¹	Alternate Boards	–			
		2 Common	Select Merch. Construction	Select Knotty ⁶	30.12	118-a	114a
		3 Common	Standard	Quality Knotty ⁶	–	111-e	204a
					30.13	118-b ⁸	114b ⁸
					–	111-f	204b
				–	118-c ⁹	114c ⁹	

1 Equivalent grades, under the same paragraph numbers in WWPA Rules, are available in Idaho White Pine. Refer to *Western Lumber Grading Rules*.
2 Western Wood Products Association's *Western Lumber Grading Rules*.
3 West Coast Lumber Inspection Bureau's *Standard Grading Rules for West Coast Lumber*.
4 National Lumber Grades Authority's *Standard Grading Rules for Canadian Lumber*.
5 Some clear grades may be specified VG (vertical grain). Common practice is to ship orders as a combination of vertical and flat grain, unless specified otherwise.
6 The widely used marketing term, "STK" usually describes a combination of Select Knotty and Quality Knotty, sometimes marketed with approximately 15% of the order in Quality Knotty.
7 The grades listed in these three columns are arranged in order of highest to lowest appearance quality; Clear Heart is the highest, and Standard and Quality Knotty are the lowest grades in this table.
8 Construction grade paragraph reference number.
9 Standard grade paragraph reference number.

The grade names in bold face type are the most widely available grades. These are often specified as a grade combination that includes some portion of material in the next higher grade; i.e. C&BTR Select, D&BTR Select, A&BTR Cedar, 2&BTR Common, 3&BTR Common or STAND&BTR (Standard & Better).

Photocopy this chart and post in a convenient place.



©2007 WWPA

Western Wood Products Association
 522 SW Fifth Avenue, Suite 500
 Portland, OR 97204-2122
 503-224-3930 fax: 503-224-3934
 e-mail: info@wwpa.org
 website: www.wwpa.org

TG-8/0717/Rev.7-07/5M